

MANISCOPIC

MLA 628
120 LSU Powershift

- Maximum lifting height : 5.13 m (TI)/5.11 m (TS)
- Maximum capacity : 2800 Kg (TI)/2500 Kg (TS)
- Maximum forward reach : 2.92 m (TI)/3.10 m (TS)
- Torque convertor
- Powershift transmission
- 123 HP Perkins intercooled engine
- 150 l./mn output Load Sensing Ultra hydraulics with simultaneous movements
- Mono - ultra joystick "kick down" control



MLA 628 - 120 LSU PS - CBA 2500

 **MANITOU**

MLA 628 - 120 LSU POWERSHIFT

 **Lifting capacity (TI/TS)**.....2800/2500 kg
at 500 mm from forks heels
Tear out force with toothed digging bucket
to ISO 8313 with tilting ram5250 daN

 **Max. lifting height**5.13/5.11 m
Speeds : unladen/loaded (in s)
Lifting6.5/6.9
Lowering4.6/4.6
Boom extension.....3.9/4.1
Boom retraction2/2.2
Times unladen (in s)
Crowd3.6
Dump2.5

 **Tyres**17.5 LR 24
Optional tyres19.5 LR 24

 **Forks (mm)**
Length1200 mm
Width x thickness125x45
Maximum distance between forks1170/1260
Carriage rotation160°/161°

 **Oil bath multidisc brakes hydraulically assisted on front/rear axles**

 **PERKINS Engine**
Type1104 C - 44 TA
Capacity4 cyl. - 4400 cm³
Power (ISO TR 14396)123 HP/90,5 kw
Maximum torque434 Nm at 1400 rpm
Direct injection
Water cooling

 **Transmission**Powershift DANA
Electrohydraulic reversing shift
4 speeds forward and 3 speeds reverse

 **Hydraulics**
Load Sensing pump with
electronic control150 l/mn - 270 bar
LSU joystick with knurled wheels and "kick down" control
Flow divider with load sensing device driving and braking

 **Capacities**
Cooling system.....20 l
Engine oil8 l
Hydraulic oil130 l
Transmission oil15.5 l
Fuel tank110 l

 **Weight unladen (with forks)**.....6680/6730kg
Overall width2.22 m
Overall height2.64 m
Turning radius (outside wheels)4.25 m
Overall length5.21/5.38 m
Ground clearance0.39 m
Drawbar pull.....9400 daN

Integrated carriage (TI)

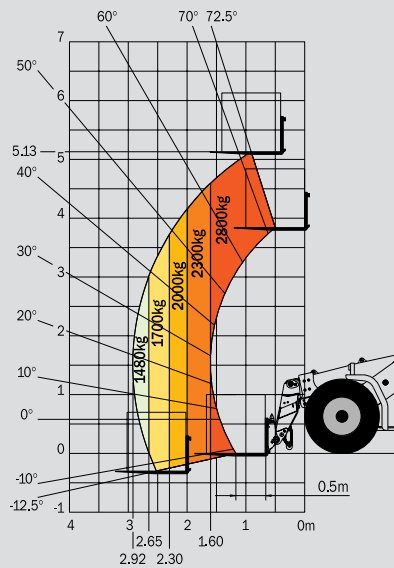

Quick fitting carriage (TS)

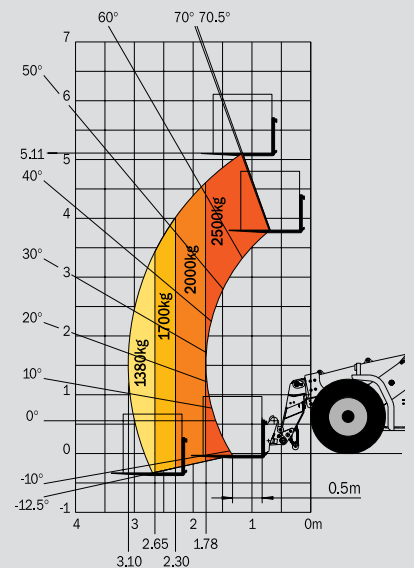

Under EN 1459 annexe B

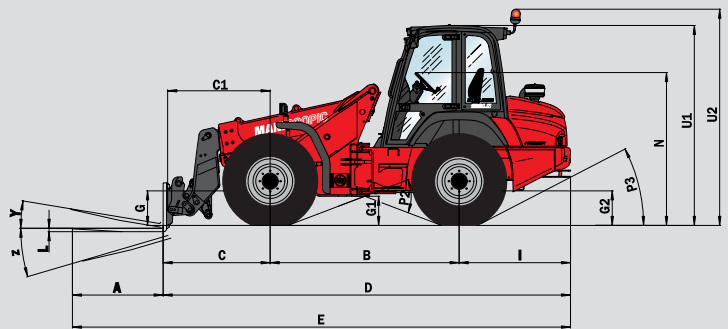

	TI	TS
A	1200	1200
B	2500	2500
C	1246	1419
C1	1665	1821
D	5221	5394
E	6421	6594
F	1770	1770
F1	1770	1770
G	455	455
G1	390	390
G2	460	460
I	1475	1475
K	1170	1260
L	45	45
N	2025 à 2050	
O	125	125
P2	42°	42°
P3	27°	27°
R	4005	4005
U	44°	44°
U1	2645	2645
U2	2860	2860
V	4405	4500
V1	2005	2005
V2	4233	4233
W	2225	2225
Y	12°	10°
Z	149°	151°

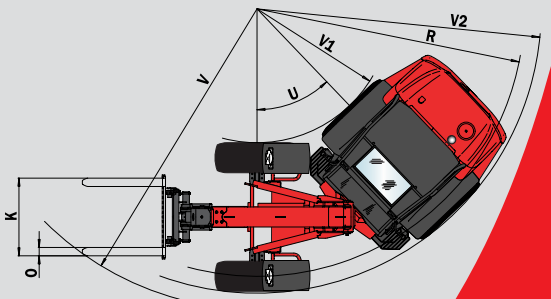
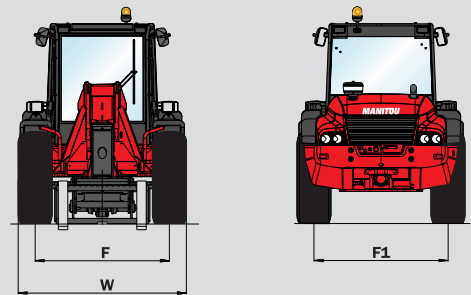

(mm)

This publication in no way constitutes an offer and the company reserves the right to alter specification without prior notice.
The MANITOU models presented in this brochure can be supplied complete with optional equipment attachments.

