

NEW



## HYDRAULIC EXCAVATOR | JS160/180/190 NLC/LC

Engine power: 93kW (125hp) Bucket capacity: 0.46 – 0.85m<sup>3</sup> Operating weight: 17,235 – 21,225kg



## STRENGTH INSIDE AND OUT.

BEFORE YOU BUY AN EXCAVATOR, YOU NEED TO KNOW IT'S GOING TO BE TOUGH ENOUGH TO PERFORM ANY JOB YOU ASK OF IT. FORTUNATELY, WITH A JCB JSI60/180/190, STRENGTH AND DURABILITY COME AS STANDARD.



1

### Boom and dipper.

- 1 A JCB JSI 60/180/190's reinforced boom and dipper is made of high tensile strength steel, with single piece wrapper plates and internal baffle plates for long life durability.
- 2 Our advanced manufacturing and assembly processes produce high precision and quality assembled components.



2

### Componentry.

- 3 Our engine technology is tried and proven; we've built 200,000 DIESELMAX units since 2004. To ensure similar longevity, the JSI 60/180/190's EcoMAX T4i/Stage IIIB engine has been tested for 110,000 hours in 70 different machines across the toughest applications and environments.
- 4 JCB JSI 60/180/190's boast the best components in the industry, including Berco running gear, Kawasaki pumps, Kayaba valve blocks and JCB EcoMAX engines.

We use Finite Element Analysis with extensive rig and endurance testing to make key components last longer.



3



4



### Structural strength.

- 5 The high-strength undercarriage of a JCB JS160/180/190 uses a fully-welded X frame construction for long-term durability even in the most demanding applications.
- 6 A closed box section revolving frame increases strength and reduces stress. It's also highly resistant to impact damage.
- 7 The 160/180/190's high-strength rigid upper frame provides maximum durability and support.
- 8 Our stiff, durable door design gives great strength and rigidity.

**UNEARTHED: KEY FACT**  
The JCB JS160/180/190 turret is welded to both the upper and lower undercarriage frame.



5



6



8



7

# MAXIMUM PRODUCTIVITY, MINIMUM SPEND.

SAVING MONEY AND TIME IS MORE IMPORTANT THAN EVER, SO WE'VE MADE SURE THE NEW JCB JSI60/180/190'S COMPONENTRY – INCLUDING THE ECOMAX T4I ENGINE – WORKS IN PERFECT HARMONY. IN TURN, YOU GET A MACHINE THAT'S AS EFFICIENT AND PRODUCTIVE AS POSSIBLE.

## Versed in versatility.

**1** JCB's quickhitch system makes attachment changing fast and easy, and is purpose-designed for the JS range.

For ultra versatility, JCB offers a full list of auxiliary pipework options including hammer, auxiliary, and low flow.

**2** An optional dozer blade increases versatility for grading.

Choose the optional rubber street pads and you can use the JSI60/180/190 on sensitive grounds like tarmac without causing damage.

**3** For waterway maintenance and deep extraction, or any application where reach is paramount, a long reach excavator is the model of choice. See long reach brochure for further details.



1



2



The JSI60/180/190 is a hugely versatile machine that's made all the more so by a big range of attachments, enabling you to carry out a wide range of tasks.



3

## Upping output.

- 4 Simultaneous tracking and excavating is smooth and fast with an intuitive multifunction operation.
- 5 A JCB JS160/180/190 has a solid, stable work platform for fast cycle times.
- 6 With a massive 11600 kgf bucket tearout and fast cycle times, the JS160/180/190 is extremely productive in all applications.
- 7 JCB's innovative hydraulic regeneration system means oil is recycled across the cylinders for faster cycle times and reduced fuel consumption.

## The efficient excavator.

- 8 JCB's new EcoMAX T4i/Stage IIIB engine uses up to 10% less fuel than our Tier 3 units, saving you money. This is partly due to the fact that EcoMAX produces high torque at just 1500 – 1600 rpm, making for improved fuel-efficient matching of the hydraulics.
- 9 To reduce noise pollution from unnecessary air flow, the JS160/180/190's engine-driven cooling fan has a proportional control system, maintaining optimum fan speed.
- 10 The JS160/180/190's variable power bands allow you to tailor performance – and therefore economy – to specific tasks.



**UNEARTHED: KEY FACT**  
A JCB JS160/180/190 has cushioned boom and dipper ends to prevent shock loadings, protect your machine and increase operator comfort.

To save fuel, JCB Auto-Idle technology automatically reduces engine speed when hydraulics aren't in use. To optimise fuel efficiency still further, the JS160/180/190 benefits from advanced hydraulic technology, including optimised hydraulic pump settings, advanced spool design, and cutting edge electronic management software.



## A COMFORTABLE FAVOURITE.

JCB EXCAVATORS ARE DESIGNED AROUND THE OPERATOR. THAT'S GOOD FOR THEM BUT EVEN BETTER FOR YOU; AFTER ALL, GREAT COMFORT AND EASE OF USE EQUALS GREAT PRODUCTIVITY.

### Visibly better.

- 1 A 70/30 front screen split gives JCB JS160/180/190's excellent front visibility. A clear view of the front right track provides easy, safe trench digging and manoeuvring.
- 2 An innovative low-level bonnet provides excellent rearward visibility.

### Comfortably in control.

- 3 The 7" colour multi-function display is easy to read in all light conditions, provides instant operational information, and has a customisable home screen.

The JS160/180/190's Tool Select feature can set up auxiliary hydraulic circuits quickly and accurately to match flow and pressure requirements of any attachment.



Light, intuitive and smooth controls improve comfort and productivity. The JS160/180/190's joystick-mounted power boost button gives extra hydraulic power fast.

A balanced slew and electronic/hydraulic controlled slew braking give speed and precision.



5

### The working environment.

**4** The JS160/180/190 creates a quieter working environment inside and out. Because we've reduced noise levels to 72dB(A) inside and 99dB(A) outside, you can use the machine at any location, any time.

JCB JS160/180/190 cabs use 6 viscous rubber mounts to minimise noise and vibration.

The positive pressure cab keeps out dirt and dust.



6

**5** JCB's climate control option offers a precisely controlled cab temperature with fresh or recirculated air. Demisting/defrosting functions keep a JS160/180/190's front window clear.

**6** There's a spacious luggage tray behind the operator's seat.

**7** A large floor area with large high grip pedals gives easy and precise tracking.



7



The JS160/180/190's cab and controls are independently adjustable so that it's easy to find the perfect operating position.

We offer tailored seating options to suit many different applications.

4

# LESS SERVICING, MORE SERVICE.

WE'VE DESIGNED THE JCB JS160/180/190 TO BE LOW MAINTENANCE AND EASILY SERVICEABLE. THIS MAKES IT AFFORDABLE, EFFICIENT AND HIGHLY PRODUCTIVE, HELPING YOU GET THE BEST SERVICE FROM YOUR MACHINE.



## Easy does it.

- 1** The air filter on a JS160/180/190 is easily accessible, and a double-element construction simplifies cleaning.
- 2** The filters on a JS160/180/190 (engine oil, hydraulic oil and fuel) are centrally located for fast, easy servicing.
- 3** Because they're mounted side by side on a JCB JS160/180/190, the engine radiator, hydraulic cooler and intercooler can be serviced individually yet cleaned easily.

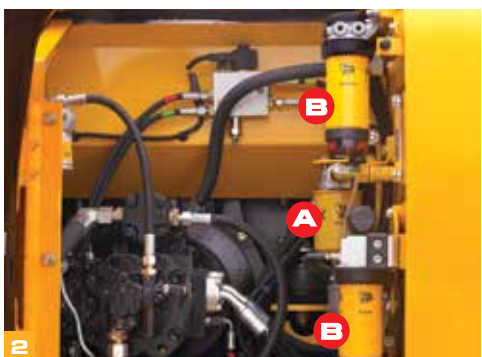

(A) Hydraulics oil filters (B) Fuel filters

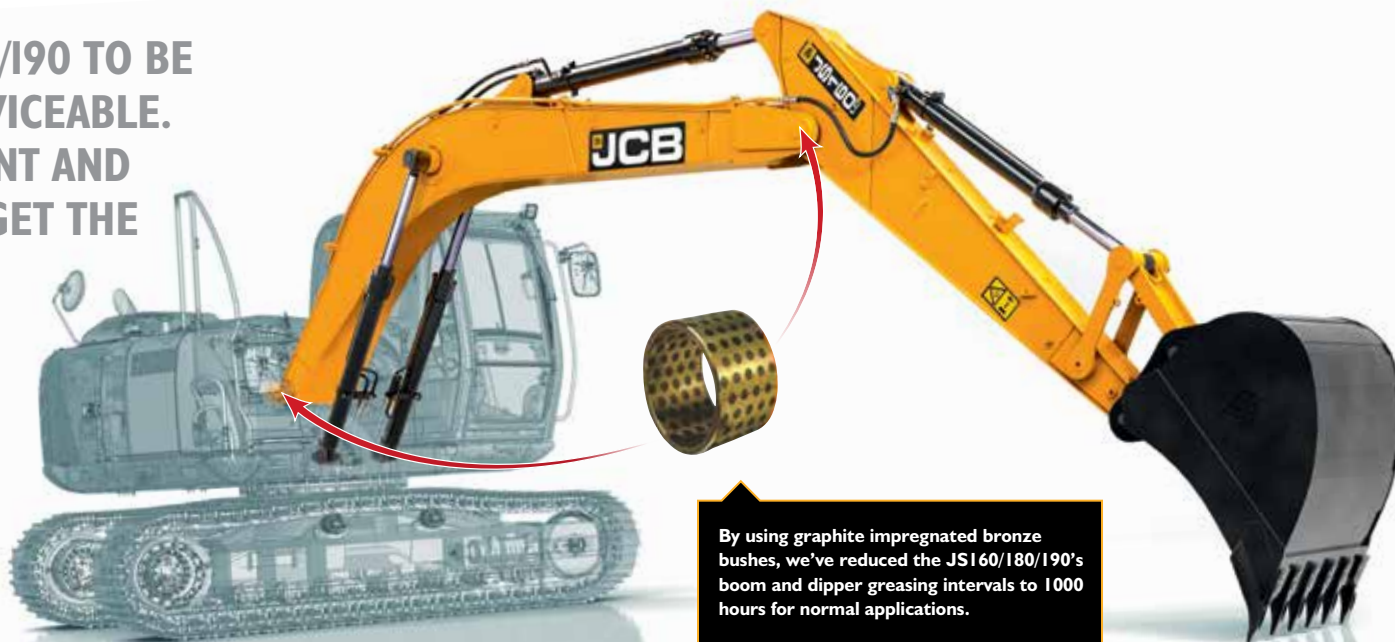

By using graphite impregnated bronze bushes, we've reduced the JS160/180/190's boom and dipper greasing intervals to 1000 hours for normal applications.

SERVICE INTERVALS	
Engine oil and oil filter	Every <b>500</b> hours
Hydraulic oil	Every <b>5000</b> hours
Hydraulic oil filter	Every <b>1000</b> hours







**Here to help.**

4 Because the EcoMAX engine doesn't need exhaust after treatment, it doesn't require costly heat-resistant lube oils.

Unlike most Tier 4i engines, JCB EcoMAX doesn't use a Diesel Particulate Filter (DPF) or SCR, saving you additional running costs.

5 We've eliminated the need for a visibowl style pre-cleaner on the JS160/180/190 with our optional new scavenger filtration system. This uses suction from the cooling fan to remove heavier particles from the induction system.

6 Our innovative recalibration option allows EcoMAX to run on lower grade fuels. This means the JS160/180/190 can be resold across different territories, which improves residuals.

7 JCB's In-Cab Monitor checks engine oil levels, coolant, and system errors on start-up.



**UNEARTHED: KEY FACT**  
JCB JS160/180/190 grease points are centralised for safe and easy access to high level pivots.

JCB JS160/180/190 bonnets open and close easily with gas-assisted cylinders, and the service bays are large and wide for good access.



# THE SAFE CHOICE.

ON-SITE SAFETY IS CRUCIAL, SO WE'VE DESIGNED THE JCB JSI60/180/190 TO INCORPORATE AS MANY CUTTING EDGE SAFEGUARDS AS POSSIBLE. IN SHORT, YOUR OPERATORS ARE IN SAFE HANDS.



**1** The JSI 60/180/190 bonnet opens front-to-rear for easy and safe engine service access.



**2** For extra peace of mind, JCB JSI 60/180/190 cabs are available with an integral Rollover Protection Structure (ROPS). It's also easy to fit JCB's Falling Objects Protection Structure (FOPS), thanks to standard fitment mounting brackets.

**3** JCB's Safety Level Lock fully isolates hydraulic functions to avoid unintended movements. Our 2GO system means a JCB JSI 60/180/190 can only be started in a safe locked position via two separate inputs.

**4** JCB JSI 60/180/190's have a large glass area and low bonnet line for superb visibility.

**5** A JCB JSI 60/180/190's steps and platforms have anti-slip punched steel plates for optimum grip, even in wet or icy conditions. Bolt-on plates have recessed bolts to reduce trip hazards.

**6** Our standard rear view and optional side view camera display uninterrupted rear and sideways views on the smart controller display.



We've fitted as standard a bulk head heat shield between the pumps and the engine to guard against heat and noise.



**7** Your JS160/180/190 is equipped with a full set of side and rear view mirrors for all round visibility and safety compliance.

**8** There's no need to climb onto the JS160/180/190 to check oil levels; all routine servicing can be done from ground level.

**9** Optional safety rails protect operators from falls when they're on the upper structure of the JS160/180/190.

**10** The JS160/180/190's optional beacons can improve on-site safety still further.

**11** Choose LED work lights for an even better field of vision on the JS160/180/190.



# LIVELINK, WORK SMARTER.

**LIVELINK IS AN INNOVATIVE SOFTWARE SYSTEM THAT LETS YOU MANAGE JCB MACHINES REMOTELY – ONLINE, BY EMAIL OR BY MOBILE PHONE. ACCESS EVERYTHING FROM MACHINE ALERTS TO FUEL REPORTS AND HISTORY INFORMATION, WITH ALL DATA STORED AT A SECURE CENTRE.**

## Productivity and cost benefits

By providing information like idle time monitoring and machine fuel consumption, JCB Livelink helps reduce your fuel usage, saving money and improving productivity. Machine location information can help improve efficiency and perhaps even reduce insurance costs.



## Maintenance benefits

Manage machine maintenance easily – accurate hours monitoring and service alerts improve maintenance planning, while real-time location data helps you manage your fleet. Critical machine alerts and maintenance history records are also available.



## Security benefits

Livelink's real-time geofencing alerts tell you when machines move out of predetermined zones, and real-time curfew alerts inform you of unauthorised usage. Further benefits include real-time location information, advanced ECU matching (pairs Livelink with the immobiliser or ECU).



## VALUE ADDED.

JCB'S WORLDWIDE CUSTOMER SUPPORT IS FIRST CLASS. WHATEVER YOU NEED AND WHEREVER YOU ARE, WE'LL BE AVAILABLE QUICKLY AND EFFICIENTLY TO HELP MAKE SURE YOUR MACHINERY IS PERFORMING TO ITS FULL POTENTIAL.



1

1 Our Technical Support Service provides instant access to factory expertise, day or night, while our Finance and Insurance teams are always on hand to provide fast, flexible, competitive quotes.

2 The global network of JCB Parts Centres is another model of efficiency; with 15 regional bases, we can deliver around 95% of all parts anywhere in the world within 24 hours. Our genuine JCB parts are designed to work in perfect harmony with your machine for optimum performance and productivity.



2

3 JCB Assetcare offers comprehensive extended warranties and service agreements, as well as service-only or repair and maintenance contracts. Irrespective of what you opt for, our maintenance teams around the world charge competitive labour rates, and offer non-obligation quotations as well as fast, efficient insurance repair work.



3

Note: JCB LIVELINK and JCB ASSETCARE may not be available in your region, so please check with your local dealer.

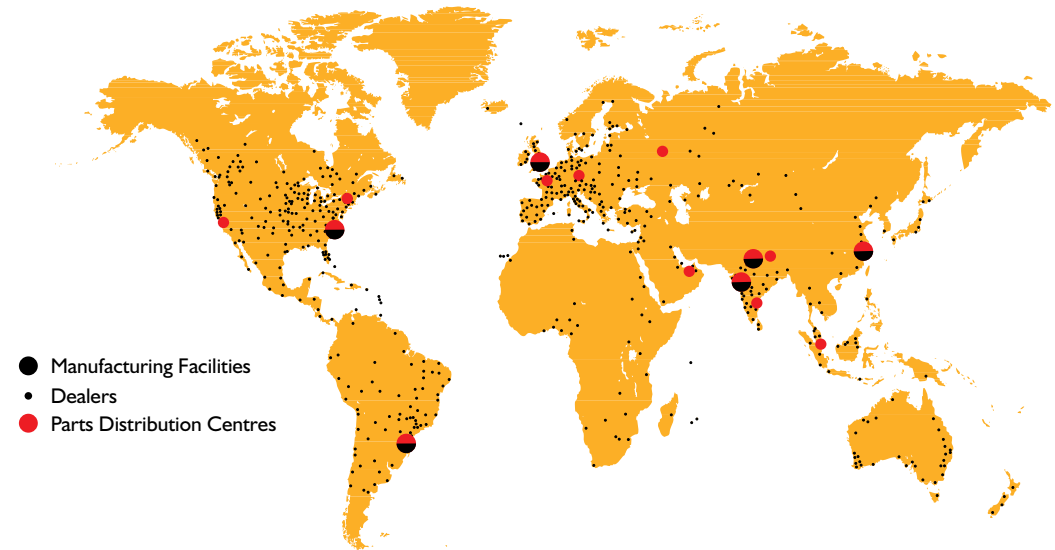

- Manufacturing Facilities
- Dealers
- Parts Distribution Centres

STATIC DIMENSIONS

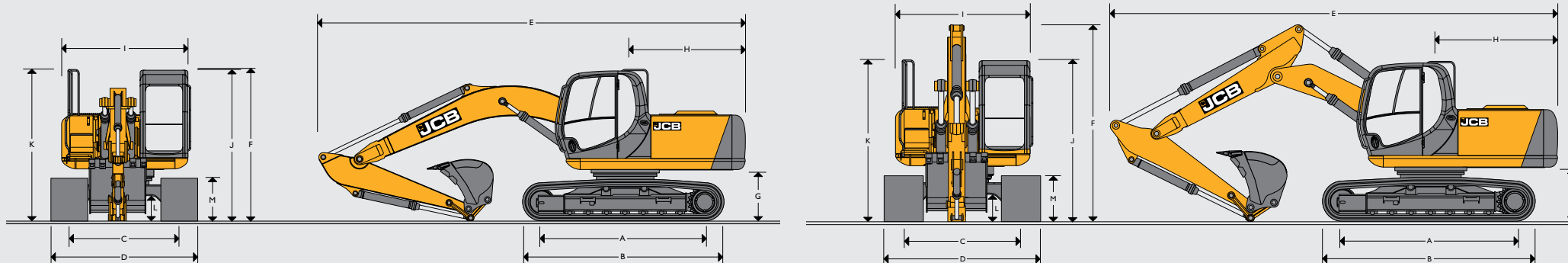

Dimensions in mm	JS160		JS160 T.A.B			JS180			JS180 T.A.B			JS190			JS190 T.A.B			
	NLC	LC	NLC	LC	3.05m	NLC	LC	3.05m	NLC	LC	3.05m	NLC	LC	3.05m	NLC	LC	3.05m	
A Track length on ground	3090	3090	3090	3090		3370	3370		3370	3370		3370	3370		3370	3370		
B Undercarriage overall length	3940	3940	3940	3940		4170	4170		4170	4170		4170	4170		4170	4170		
C Track gauge	1990	2200	1990	2200		1990	2200		1990	2200		1990	2200		1990	2200		
D Width over tracks (500mm trackshoes)	2490	–	2490	–		2490	–		2490	–		2490	–		2490	–		
D Width over tracks (600mm trackshoes)	2590	2800	2590	2800		2590	2800		2590	2800		2590	2800		2590	2800		
D Width over tracks (700mm trackshoes)	2690	2900	2690	2900		2690	2900		2690	2900		2690	2900		2690	2900		
D Width over tracks (800mm trackshoes)	–	3000	–	3000		–	3000		–	3000		–	3000		–	3000		
D Width over tracks (900mm trackshoes)	–	3100	–	3100		–	–		–	–		–	–		–	–		
<b>Dipper lengths</b>	<b>2.25m</b>	<b>2.7m</b>	<b>3.05m</b>	<b>2.25m</b>	<b>2.7m</b>	<b>3.05m</b>	<b>2.25m</b>	<b>2.7m</b>	<b>3.05m</b>	<b>2.25m</b>	<b>2.7m</b>	<b>3.05m</b>	<b>2.25m</b>	<b>2.7m</b>	<b>3.05m</b>	<b>2.25m</b>	<b>2.7m</b>	<b>3.05m</b>
E Transport length	8338	8298	8388	8624	8646	8616	8366	8326	8415	8652	8674	8644	8366	8326	8415	8611	8666	8636
F Transport height	2992	2992	2992	2854	2738	2801	3014	3014	3014	2876	2760	2823	3014	3014	3014	2876	2760	2823
<b>Dimensions in mm</b>	<b>NLC &amp; LC</b>		<b>NLC &amp; LC</b>			<b>NLC &amp; LC</b>			<b>NLC &amp; LC</b>			<b>NLC &amp; LC</b>			<b>NLC &amp; LC</b>			
G Counterweight clearance	1050		1050			1072			1072			1072			1072			
H Tailswing radius	2338		2338			2338			2338			2338			2338			
I Width of superstructure	2470		2470			2470			2470			2470			2470			
J Height over cab	2965		2965			2987			2987			2987			2987			
K Height over grab rail	2992		2992			3014			3014			3014			3014			
L Ground clearance	470		470			486			486			486			486			
M Track height	880		880			885			885			885			885			
Height with upperstructure safety rails	3092		3092			3114			3114			3114			3114			

ENGINE	
Model	JCB EcoMAX 444 TCA 93 EU Stage IIIB EPA Tier 4 interim compliant
Type	Water cooled, 4-stroke, 4-cylinder in-line, common rail, direct injection, variable geometry turbocharged, intercooled, diesel
Nett power (ISO 3046-1NF)	93kW (125hp) at 2200rpm
Piston Displacement	4.399 litres
Injection	Electronic governor
Air Filtration	Dry element with secondary safety element and in cab warning indicator
Cooling	Large capacity radiator
Starting system	24 volt – 4kW
Batteries	2 x 12 volt
Alternator	24 volt 55 amp
Refuelling pump	Electric type (optional)

SWING SYSTEM	
Swing motor	Axial piston type
Swing brake	Hydraulic braking plus automatic spring applied disc type parking brake
Final drive	Planetary reduction
Swing speed	10.4 rpm
Swing gear	Large diameter, internally toothed fully sealed grease bath lubricated
Swing lock	Multi position switchable brake

UNDERCARRIAGE					
Carriage options	NLC – Narrow long carriage and LC – Long carriage				
Recovery point	Front and rear				
Upper & lower rollers	Heat treated, sealed and lubricated				
Track adjustment	Grease cylinder type				
Track type	Sealed and lubricated				
Track idler	Sealed and lubricated, with spring cushioned recoil				
Track shoes	<b>JSI60 NLC &amp; LC</b>	<b>JSI80 NLC</b>	<b>JSI80 LC</b>	<b>JSI90 NLC</b>	<b>JSI90 LC</b>
	500mm triple grouser	500mm		500mm	
	600mm triple grouser	600mm	600mm	600mm	600mm
	700mm triple grouser	700mm	700mm	700mm	700mm
	800mm triple grouser		800mm		800mm
	900mm triple grouser				
Rollers and Shoes (each side)	<b>JSI60 NLC &amp; LC</b>	<b>JSI80 NLC &amp; LC</b>		<b>JSI90 NLC &amp; LC</b>	
Upper rollers	2	2		2	
Lower rollers	7	7		7	
Track shoes	43	46		46	
Track guides	1	2		2	

HYDRAULIC SYSTEM	
<b>Pumps</b>	
Main pumps	2 variable displacement axial piston type
Maximum flow	2 x 164 L/min
Servo pump	Gear type
Maximum flow	20.5 L/min
<b>Control valve</b>	
A combined ten spool control valve with auxiliary service spool as standard	
<b>Relief valve settings</b>	
Boom/Arm/Bucket	314 bar
With power boost	343 bar
Swing circuit	279 bar
Travel circuit	343 bar
Pilot control	40 bar
<b>Filtration</b>	
In tank	150 micron, suction strainer
Main return line	10 micron, fibreform element
Pilot line	10 micron, paper element
Hydraulic hammer return	10 micron, reinforced microform element

TRACK DRIVE			
Type	Fully hydrostatic, three speed with autoshift between high and medium speed		
Travel motors	Variable swash axial piston type, fully guarded within undercarriage frame		
Final drive	Planetary reduction, bolt-on sprockets		
Service brake	Hydraulic counter balance valve to prevent overspeeding on gradients		
Park brake	Disc type, spring applied, automatic hydraulic release		
Gradeability	70% (35 deg) continuous		
Travel speed	<b>JSI60 NLC &amp; LC</b>	<b>JSI80 NLC &amp; LC</b>	<b>JSI90 NLC &amp; LC</b>
	High – 5.5 kph	High – 5.5 kph	High – 4.2 kph
	Mid – 3.2 kph	Mid – 3.2 kph	Mid – 2.4 kph
	Low – 1.7 kph	Low – 1.7 kph	Low – 1.3 kph
Tractive effort	167 kN (17029 kgf)	167 kN (17029 kgf)	223.5 kN (22739 kgf)

SERVICE CAPACITIES			
	<b>JSI60 NLC &amp; LC (Litres)</b>	<b>JSI80 NLC &amp; LC (Litres)</b>	<b>JSI90 NLC &amp; LC (Litres)</b>
Fuel tank	220	220	220
Engine coolant	19.7	19.7	19.7
Engine oil	20.4	20.4	20.4
Swing reduction gear	6	6	6
Track reduction gear (each side)	4	4.4	4.4
Hydraulic system	142	142	142
Hydraulic tank	73.0	73.0	73.0

## WEIGHTS AND GROUND BEARING PRESSURES

**JSI 160 NLC/LC MONO** – Machine equipped with 5.15m Monoboom, 3.05m Dipper, 0.9m<sup>3</sup> Bucket, operator and full fuel tank

Shoe Width	Operating Weight	Bearing Pressure
500mm / NLC	17235kg	0.56kg/sq.cm
600mm / LC	17538kg	0.47kg/sq.cm
700mm / LC	17774kg	0.41kg/sq.cm
800mm / LC	18038kg	0.36kg/sq.cm
900mm / LC	18436kg	0.33kg/sq.cm

**JSI 160 NLC/LC T.A.B.** – Machine equipped with 5.35m T.A.B. boom, 3.05m Dipper, 0.9m<sup>3</sup> Bucket, operator and full fuel tank.

500mm / NLC	17999kg	0.58kg/sq. cm
600mm / LC	18302kg	0.49kg/sq.cm
700mm / LC	18538kg	0.45kg/sq. cm
800mm / LC	18802kg	0.38kg/sq.cm
900mm / LC	19200kg	0.34kg/sq.cm

**JSI 180 NLC MONO** – Machine equipped with 5.15m Monoboom, 3.05m Dipper, 0.9m<sup>3</sup> Bucket, operator and full fuel tank.

500mm	18336kg	0.54kg/sq.cm
-------	---------	--------------

**JSI 180 LC MONO** – Machine equipped with 5.15m Monoboom, 3.05m Dipper, 0.9m<sup>3</sup> Bucket, operator and full fuel tank.

600mm	18897kg	0.47kg/sq.cm
700mm	19150kg	0.41kg/sq.cm
800mm	19438kg	0.36kg/sq.cm

**JSI 180 NLC T.A.B.** – Machine equipped with 5.35m T.A.B. boom, 3.05m Dipper, 0.9m<sup>3</sup> Bucket, operator and full fuel tank.

500mm	19200kg	0.57kg/sq.cm
-------	---------	--------------

**JSI 180 LC T.A.B.** – Machine equipped with 5.35m T.A.B. boom, 3.05m Dipper, 0.9m<sup>3</sup> Bucket, operator and full fuel tank.

600mm	19661kg	0.49kg/sq.cm
700mm	19914kg	0.42kg/sq.cm
800mm	20202kg	0.37kg/sq.cm

**JSI 190 NLC MONO** – Machine equipped with 5.15m Monoboom, 3.05m Dipper, 0.9m<sup>3</sup> Bucket, operator and full fuel tank.

500mm	19658kg	0.58kg/sq.cm
600mm	19911kg	0.49kg/sq.cm

**JSI 190 LC MONO** – Machine equipped with 5.15m Monoboom, 3.05m Dipper, 0.9m<sup>3</sup> Bucket, operator and full fuel tank.

600mm	19961kg	0.49kg/sq.cm
700mm	20197kg	0.43kg/sq.cm
800mm	20461kg	0.38kg/sq.cm

**JSI 190 NLC T.A.B.** – Machine equipped with 5.35m T.A.B. boom, 3.05m Dipper, 0.9m<sup>3</sup> Bucket, operator and full fuel tank.

500mm	20422kg	0.60kg/sq.cm
600mm	20675kg	0.51kg/sq.cm

**JSI 190 LC T.A.B.** – Machine equipped with 5.35m T.A.B. boom, 3.05m Dipper, 0.9m<sup>3</sup> Bucket, operator and full fuel tank.

600mm	20725kg	0.51kg/sq.cm
700mm	20961kg	0.44kg/sq.cm
800mm	21225kg	0.39kg/sq.cm

## BUCKET AND ARM COMBINATION

**JSI 160 MONO** (No quickhitch fitted)

Arm length	LC			NLC			Bucket weight
	2.25m	2.70m	3.05m	2.25m	2.70m	3.05m	
GP Bucket 762mm, 0.46m <sup>3</sup>	□	□	□	□	□	□	478kg
GP Bucket 914mm, 0.59m <sup>3</sup>	□	□	□	□	□	□	525kg
GP Bucket 1067mm, 0.718m <sup>3</sup>	□	□	□	□	□	■	613kg
GP Bucket 1219mm, 0.85m <sup>3</sup>	□	■	●	■	●	●	693kg

**JSI 160 MONO** (Quickhitch fitted)\*

Arm length	LC			NLC			Bucket weight
	2.25m	2.70m	3.05m	2.25m	2.70m	3.05m	
GP Bucket 762mm, 0.46m <sup>3</sup>	□	□	□	□	□	□	478kg
GP Bucket 914mm, 0.59m <sup>3</sup>	□	□	□	□	■	■	525kg
GP Bucket 1067mm, 0.718m <sup>3</sup>	□	□	■	■	■	●	613kg
GP Bucket 1219mm, 0.85m <sup>3</sup>	■	●	●	●	●	✘	693kg

**JSI 160 TAB** (No quickhitch fitted)

Arm length	LC			NLC			Bucket weight
	2.25m	2.70m	3.05m	2.25m	2.70m	3.05m	
GP Bucket 762mm, 0.46m <sup>3</sup>	□	□	□	□	□	□	478kg
GP Bucket 914mm, 0.59m <sup>3</sup>	□	□	□	□	□	□	525kg
GP Bucket 1067mm, 0.718m <sup>3</sup>	□	□	□	□	□	■	613kg
GP Bucket 1219mm, 0.85m <sup>3</sup>	□	■	●	■	●	●	693kg

**JSI 160 TAB** (Quickhitch fitted)\*

Arm length	LC			NLC			Bucket weight
	2.25m	2.70m	3.05m	2.25m	2.70m	3.05m	
GP Bucket 762mm, 0.46m <sup>3</sup>	□	□	□	□	□	□	478kg
GP Bucket 914mm, 0.59m <sup>3</sup>	□	□	□	□	■	■	525kg
GP Bucket 1067mm, 0.718m <sup>3</sup>	□	□	■	■	■	●	613kg
GP Bucket 1219mm, 0.85m <sup>3</sup>	■	●	●	●	●	✘	693kg

□ = Suitable for general excavating (materials up to 2000kg/cu.m).

■ = Suitable for light excavating (materials up to 1600kg/cu.m.)

● = Suitable for grading & loading materials up to 1200kg/cu.m).

✘ = Not recommended

\* Bucket capacity using JCB quickhitch only (quickhitch = 186kg).



**BUCKET AND ARM COMBINATION**

**JSI80 MONO (No quickhitch fitted)**

Arm length	LC			NLC			Bucket weight
	2.25m	2.70m	3.05m	2.25m	2.70m	3.05m	
GP Bucket 762mm, 0.46m <sup>3</sup>	□	□	□	□	□	□	478kg
GP Bucket 914mm, 0.59m <sup>3</sup>	□	□	□	□	□	□	525kg
GP Bucket 1067mm, 0.718m <sup>3</sup>	□	□	□	□	□	□	613kg
GP Bucket 1219mm, 0.85m <sup>3</sup>	□	□	■	□	■	●	693kg

**JSI80 MONO (Quickhitch fitted)\***

Arm length	LC			NLC			Bucket weight
	2.25m	2.70m	3.05m	2.25m	2.70m	3.05m	
GP Bucket 762mm, 0.46m <sup>3</sup>	□	□	□	□	□	□	478kg
GP Bucket 914mm, 0.59m <sup>3</sup>	□	□	□	□	□	□	525kg
GP Bucket 1067mm, 0.718m <sup>3</sup>	□	□	■	□	□	■	613kg
GP Bucket 1219mm, 0.85m <sup>3</sup>	□	■	●	■	●	●	693kg

**JSI80 TAB (No quickhitch fitted)**

Arm length	LC			NLC			Bucket weight
	2.25m	2.70m	3.05m	2.25m	2.70m	3.05m	
GP Bucket 762mm, 0.46m <sup>3</sup>	□	□	□	□	□	□	478kg
GP Bucket 914mm, 0.59m <sup>3</sup>	□	□	□	□	□	□	525kg
GP Bucket 1067mm, 0.718m <sup>3</sup>	□	□	□	□	□	□	613kg
GP Bucket 1219mm, 0.85m <sup>3</sup>	□	□	■	□	■	●	693kg

**JSI80 TAB (Quickhitch fitted)\***

Arm length	LC			NLC			Bucket weight
	2.25m	2.70m	3.05m	2.25m	2.70m	3.05m	
GP Bucket 762mm, 0.46m <sup>3</sup>	□	□	□	□	□	□	478kg
GP Bucket 914mm, 0.59m <sup>3</sup>	□	□	□	□	□	□	525kg
GP Bucket 1067mm, 0.718m <sup>3</sup>	□	□	■	□	□	■	613kg
GP Bucket 1219mm, 0.85m <sup>3</sup>	□	■	●	■	●	●	693kg

□ = Suitable for general excavating (materials up to 2000kg/cu.m).

■ = Suitable for light excavating (materials up to 1600kg/cu.m.)

● = Suitable for grading & loading materials up to 1200kg/cu.m).

✘ = Not recommended

\* Bucket capacity using JCB quickhitch only (quickhitch = 186kg).

**BUCKET AND ARM COMBINATION**

**JSI90 MONO (No quickhitch fitted)**

Arm length	LC			NLC			Bucket weight
	2.25m	2.70m	3.05m	2.25m	2.70m	3.05m	
GP Bucket 762mm, 0.46m <sup>3</sup>	□	□	□	□	□	□	478kg
GP Bucket 914mm, 0.59m <sup>3</sup>	□	□	□	□	□	□	525kg
GP Bucket 1067mm, 0.718m <sup>3</sup>	□	□	□	□	□	□	613kg
GP Bucket 1219mm, 0.85m <sup>3</sup>	□	□	■	□	■	●	693kg

**JSI90 MONO (Quickhitch fitted)\***

Arm length	LC			NLC			Bucket weight
	2.25m	2.70m	3.05m	2.25m	2.70m	3.05m	
GP Bucket 762mm, 0.46m <sup>3</sup>	□	□	□	□	□	□	478kg
GP Bucket 914mm, 0.59m <sup>3</sup>	□	□	□	□	□	□	525kg
GP Bucket 1067mm, 0.718m <sup>3</sup>	□	□	■	□	□	■	613kg
GP Bucket 1219mm, 0.85m <sup>3</sup>	□	■	●	■	●	●	693kg

**JSI90 TAB (No quickhitch fitted)**

Arm length	LC			NLC			Bucket weight
	2.25m	2.70m	3.05m	2.25m	2.70m	3.05m	
GP Bucket 762mm, 0.46m <sup>3</sup>	□	□	□	□	□	□	478kg
GP Bucket 914mm, 0.59m <sup>3</sup>	□	□	□	□	□	□	525kg
GP Bucket 1067mm, 0.718m <sup>3</sup>	□	□	□	□	□	□	613kg
GP Bucket 1219mm, 0.85m <sup>3</sup>	□	□	■	□	■	●	693kg

**JSI90 TAB (Quickhitch fitted)\***

Arm length	LC			NLC			Bucket weight
	2.25m	2.70m	3.05m	2.25m	2.70m	3.05m	
GP Bucket 762mm, 0.46m <sup>3</sup>	□	□	□	□	□	□	478kg
GP Bucket 914mm, 0.59m <sup>3</sup>	□	□	□	□	□	□	525kg
GP Bucket 1067mm, 0.718m <sup>3</sup>	□	□	■	□	□	■	613kg
GP Bucket 1219mm, 0.85m <sup>3</sup>	□	■	●	■	●	●	693kg

□ = Suitable for general excavating (materials up to 2000kg/cu.m).

■ = Suitable for light excavating (materials up to 1600kg/cu.m.)

● = Suitable for grading & loading materials up to 1200kg/cu.m).

✘ = Not recommended

\* Bucket capacity using JCB quickhitch only (quickhitch = 186kg).

WORKING RANGE				
		JS160 NLC/LC MONOBOOM	JS180 NLC/LC MONOBOOM	JS190 NLC/LC MONOBOOM
<b>Boom length:</b>		<b>5.15m</b>	<b>5.15m</b>	<b>5.15m</b>
<b>Dipper length:</b>		<b>2.25m</b>	<b>2.25m</b>	<b>2.25m</b>
A	Maximum digging reach	mm	8507	8514
B	Maximum digging reach (on ground)	mm	8326	8368
C	Maximum digging depth	mm	5482	5799
D	Maximum digging height	mm	8863	9398
E	Maximum dumping height	mm	6535	7048
F	Maximum vertical wall cut depth	mm	4912	5229
G	Minimum swing radius	mm	3000	3000
Bucket rotation			182°	182°
Maximum dipper tearout (ISO 6015)		kgf	8754	8754
Maximum bucket tearout (ISO 6015)		kgf	11839	11839
<b>Dipper length:</b>		<b>2.70m</b>	<b>2.70m</b>	<b>2.70m</b>
A	Maximum digging reach	mm	8908	8908
B	Maximum digging reach (on ground)	mm	8735	8769
C	Maximum digging depth	mm	5940	6252
D	Maximum digging height	mm	9050	9663
E	Maximum dumping height	mm	6726	7321
F	Maximum vertical wall cut depth	mm	5370	5682
G	Minimum swing radius	mm	3000	3000
Bucket rotation			182°	182°
Maximum dipper tearout (ISO 5016)		kgf	7619	7619
Maximum bucket tearout (ISO 5016)		kgf	11839	11839
<b>Dipper length:</b>		<b>3.05m</b>	<b>3.05m</b>	<b>3.05m</b>
A	Maximum digging reach	mm	9223	9223
B	Maximum digging reach (on ground)	mm	9056	9088
C	Maximum digging depth	mm	6286	6598
D	Maximum digging height	mm	9219	9888
E	Maximum dumping height	mm	6891	7543
F	Maximum vertical wall cut depth	mm	5646	6028
G	Minimum swing radius	mm	3000	3000
Bucket rotation			182°	182°
Maximum dipper tearout (ISO 5016)		kgf	7003	7003
Maximum bucket tearout (ISO 5016)		kgf	11839	11839

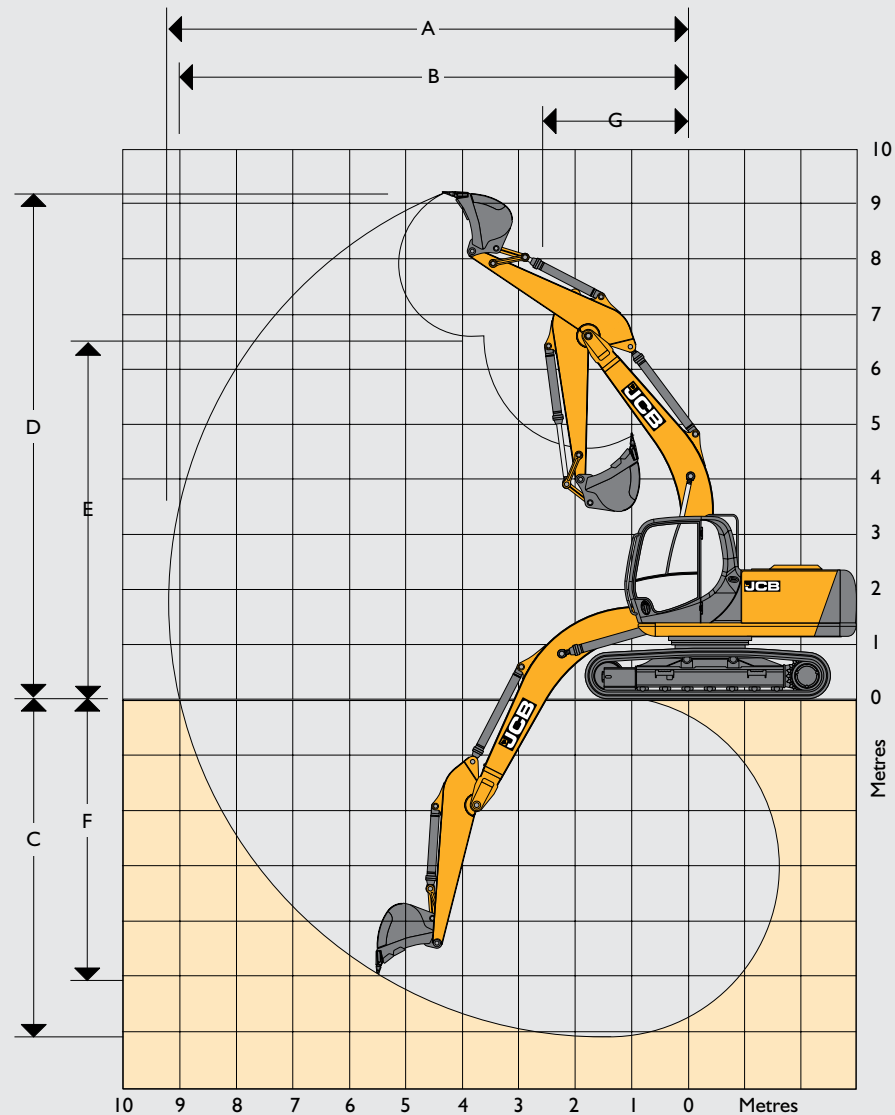





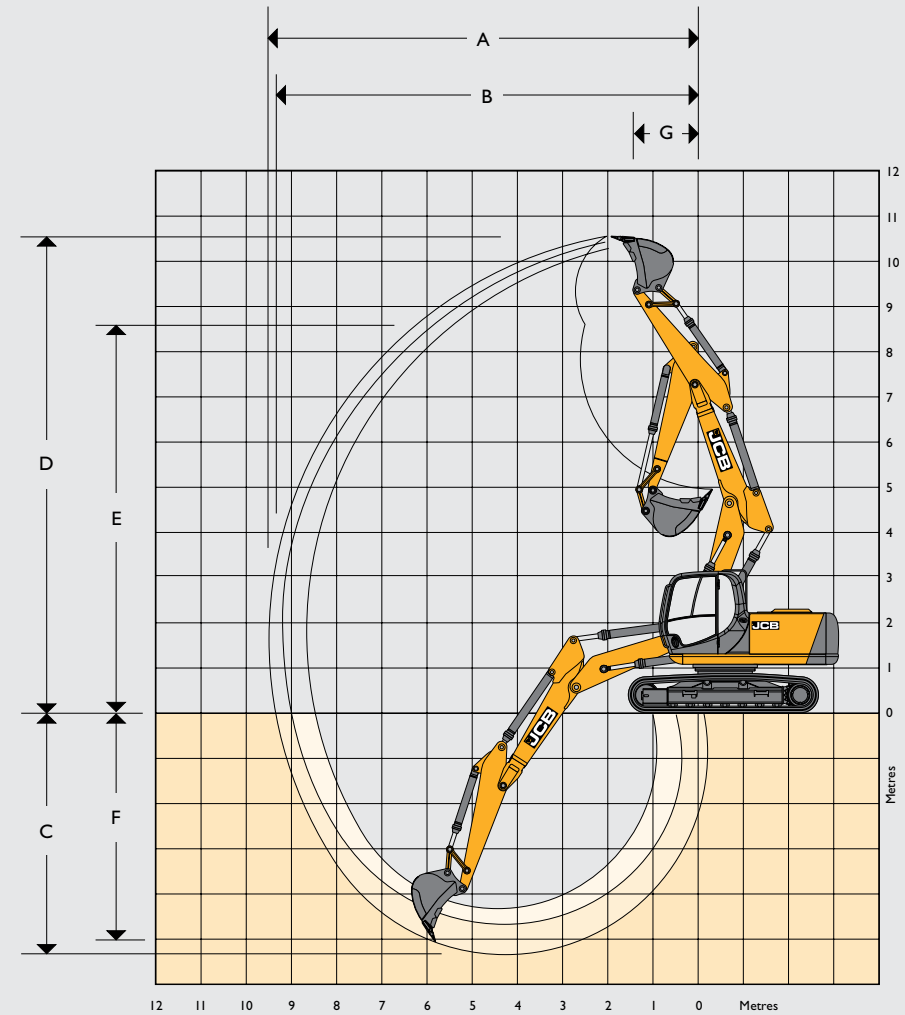







**WORKING RANGE**













		JSI160 NLC/LC T.A.B.	JSI180 NLC/LC T.A.B.	JSI190 NLC/LC T.A.B.
<b>T.A. Boom length:</b>		<b>5.35m</b>	<b>5.35m</b>	<b>5.35m</b>
<b>Dipper length:</b>		<b>2.25m</b>	<b>2.25m</b>	<b>2.25m</b>
A	Maximum digging reach	mm 8831	8831	8831
B	Maximum digging reach (on ground)	mm 8652	8652	8652
C	Maximum digging depth	mm 5376	5354	5354
D	Maximum digging height	mm 10226	10248	10248
E	Maximum dumping height	mm 7976	8000	8000
F	Maximum vertical wall cut depth	mm 4254	4232	4232
G	Minimum swing radius	mm 2170	2170	2170
Bucket rotation		182°	182°	182°
Maximum dipper tearout (ISO 6015)		kgf 8754	8754	8754
Maximum bucket tearout (ISO 6015)		kgf 11839	11839	11839
<b>Dipper length:</b>		<b>2.70m</b>	<b>2.70m</b>	<b>2.70m</b>
A	Maximum digging reach	mm 9260	9260	9260
B	Maximum digging reach (on ground)	mm 9094	9094	9094
C	Maximum digging depth	mm 5808	5786	5786
D	Maximum digging height	mm 10652	10674	10674
E	Maximum dumping height	mm 8366	8444	8444
F	Maximum vertical wall cut depth	mm 4721	4699	4699
G	Minimum swing radius	mm 2227	2227	2227
Bucket rotation		182°	182°	182°
Maximum dipper tearout (ISO 5016)		kgf 7619	7619	7619
Maximum bucket tearout (ISO 5016)		kgf 11839	11839	11839
<b>Dipper length:</b>		<b>3.05m</b>	<b>3.05m</b>	<b>3.05m</b>
A	Maximum digging reach	mm 9592	9592	9592
B	Maximum digging reach (on ground)	mm 9463	9463	9463
C	Maximum digging depth	mm 6130	6108	6108
D	Maximum digging height	mm 10800	10822	10822
E	Maximum dumping height	mm 8667	8672	8672
F	Maximum vertical wall cut depth	mm 5233	5211	5211
G	Minimum swing radius	mm 2587	2587	2587
Bucket rotation		182°	182°	182°
Maximum dipper tearout (ISO 5016)		kgf 7003	7003	7003
Maximum bucket tearout (ISO 5016)		kgf 11839	11839	11839













**LIFT CAPACITIES – DIPPER LENGTH: 2.25M, 5.15M MONOBOOM, TRACKSHOES: 700MM, NO BUCKET. JSI60 LC MONO**

Reach	1.5m		3m		4.5m		6m		7.5m		Capacity at Max Reach			
														
Load Point Ht.	kg	kg	kg	kg	kg	kg	kg	kg	kg	kg	kg	kg	kg	mm
7.5m												3880*	3880*	4495
6.0m												3340*	3340*	5961
4.5m					5530*	5530*	5000	3660				3190*	2990	6797
3.0m					6900*	5360	4870	3530				3220*	2670	7230
1.5m					7260	5060	4720	3400				3430*	2560	7331
0m			5270*	5270*	7070	4900	4620	3300				3640	2630	7116
- 1.5m	5970*	5970*	10710*	9160	7030	4860	4590	3280				4080	2930	6554
- 3.0m			10790*	9330	7120	4940						5250	3740	5535
- 4.5m														

**LIFT CAPACITIES – DIPPER LENGTH: 2.70M, 5.15M MONOBOOM, TRACKSHOES: 700MM, NO BUCKET. JSI60 LC MONO**

Reach	1.5m		3m		4.5m		6m		7.5m		Capacity at Max Reach			
														
Load Point Ht.	kg	kg	kg	kg	kg	kg	kg	kg	kg	kg	kg	kg	kg	mm
7.5m												2820*	2820*	5128
6.0m							3840*	3750				2500*	2500*	6449
4.5m					4980*	4980*	4610*	3690				2410*	2410	7228
3.0m			9630*	9630*	6370*	5440	4890	3550	3190*	2530		2440*	2440*	7636
1.5m			5060*	5060*	7300	5100	4730	3400	3400	2460		2600*	2350	7732
0m			6390*	6390*	7070	4890	4600	3280	3150*	2420		2900*	2410	7529
- 1.5m	5750*	5750*	10070*	9060	6990	4810	4550	3230				3500*	2640	7000
- 3.0m	9790*	9790*	11600*	9190	7030	4860	4600	3290				4550	3250	6058
- 4.5m			8470*	8470*								5590*	5170	4443





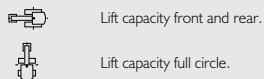





**LIFT CAPACITIES – DIPPER LENGTH: 3.05M, 5.15M MONOBOOM, TRACKSHOES: 700MM, NO BUCKET. JSI60 LC MONO**













Reach	1.5m		3m		4.5m		6m		7.5m		Capacity at Max Reach			
														
Load Point Ht.	kg	kg	kg	kg	kg	kg	kg	kg	kg	kg	kg	kg	kg	mm
7.5m												2440*	2440*	5707
6.0m							3880*	3760				2160*	2160*	6916
4.5m							4260*	3680	2690*	2540		2070*	2070*	7647
3.0m			8500*	8500*	5880*	5440	4870*	3520	3430	2490		2070*	2070*	8033
1.5m			6080*	6080*	7270	5060	4680	3350	3350	2410		2170*	2130	8124
0m			6140*	6140*	6980	4800	4530	3210	3280	2350		2380*	2170	7931
- 1.5m	4890*	4890*	9020*	8850	6870	4700	4460	3140				2780*	2360	7431
- 3.0m	8390*	8390*	11970*	8960	6890	4720	4480	3170				3610*	2830	6553
- 4.5m			9340*	9250	6330*	4890						5160*	4130	5101















**Notes:**

1. The above loads are in compliance with SAE and ISO Hydraulic Excavator Lift Capacity Standards.
2. They do not exceed 87% of hydraulic lifting capacity or 75% of tipping load.
3. Rated loads marked with an asterisk(\*) are limited by hydraulic capacity rather than tipping load.

LIFT CAPACITIES – DIPPER LENGTH: 2.25M, 5.15M MONOBOOM, TRACKSHOES: 500MM, NO BUCKET.													JSI60 NLC MONO	
Reach	1.5m		3m		4.5m		6m		7.5m		Capacity at Max Reach			
														
Load Point Ht.	kg	kg	kg	kg	kg	kg	kg	kg	kg	kg	kg	kg	mm	
7.5m												3880*	3880*	4495
6.0m												3340*	3280	5961
4.5m					5530*	5000	4860	3220				3190*	2620	6797
3.0m					6900*	4680	4720	3100				3230*	2230	7230
1.5m					7040	4380	4580	2960				3410	2230	7331
0m			5270*	5270*	6850	4230	4470	2870				3520	2290	7116
- 1.5m	5970*	5970*	10710*	7740	6820	4190	4450	2850				3950	2550	6554
- 3.0m			10790*	7890	6910	4270						5090	3250	5535
- 4.5m														





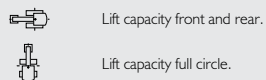



LIFT CAPACITIES – DIPPER LENGTH: 2.70M, 5.15M MONOBOOM, TRACKSHOES: 500MM, NO BUCKET.													JSI60 NLC MONO	
Reach	1.5m		3m		4.5m		6m		7.5m		Capacity at Max Reach			
														
Load Point Ht.	kg	kg	kg	kg	kg	kg	kg	kg	kg	kg	kg	kg	mm	
7.5m												2820*	2820*	5128
6.0m							3840*	3310				2500*	2500*	6449
4.5m							4610*	3250				2410*	2390	7228
3.0m			9630*	8720*	7980*	4980	4750	3110	3190*	2210		2440*	2140	7636
1.5m			5060*	5060*	6370	4750	4580	2960	3290	2150		2600*	2050	7732
0m			6390*	6390*	7090	4420	4460	2850	3150*	2100		2900*	2090	7529
- 1.5m	5750*	5750*	10070*	7630	6850	4210	4410	2800				3500*	2300	7000
- 3.0m	9790*	9790*	11600*	7760	6770	4150	4460	2850				4400	2820	6058
- 4.5m			8470*	8050	6820*	4190						5590*	4480	4443

LIFT CAPACITIES – DIPPER LENGTH: 3.05M, 5.15M MONOBOOM, TRACKSHOES: 500MM, NO BUCKET.													JSI60 NLC MONO	
Reach	1.5m		3m		4.5m		6m		7.5m		Capacity at Max Reach			
														
Load Point Ht.	kg	kg	kg	kg	kg	kg	kg	kg	kg	kg	kg	kg	mm	
7.5m												2440*	2440*	5707
6.0m							3880*	3310				2160*	2160*	6916
4.5m							4260*	3240	2690*	2220		2070*	2070*	7647
3.0m			8500*	8500*	5880*	4750	4720	3080	3320	2170		2070*	1920	8033
1.5m			6080*	6080*	7050	4370	4530	2910	3240	2090		2170*	1840	8124
0m			6140*	6140*	6770	4130	4390	2770	3170	2030		2380*	1870	7931
- 1.5m	4890*	4890*	9020*	7430	6650	4030	4310	2710				2780*	2040	7431
- 3.0m	8390*	8390*	11970*	7530	6670	4050	7340	2730				3610*	2450	6553
- 4.5m			9340*	7810	6330*	4220						5160*	3580	5101











Notes: 1. The above loads are in compliance with SAE and ISO Hydraulic Excavator Lift Capacity Standards.  
 2. They do not exceed 87% of hydraulic lifting capacity or 75% of tipping load.  
 3. Rated loads marked with an asterisk(\*) are limited by hydraulic capacity rather than tipping load.











**LIFT CAPACITIES – DIPPER LENGTH: 2.25M, 5.35M T.A.B., TRACKSHOES: 700MM, NO BUCKET. JS160 LC T.A.B.**

Reach	3m		4.5m		6m		7.5m		Capacity at Max Reach		mm
											
Load Point Ht.	kg	kg	kg	kg	kg	kg	kg	kg	kg	kg	mm
9.0m									7240*	7240*	2218
7.5m	5930*	5930*	5780*	5780*					4160*	4160*	5009
6.0m	5030*	5030*	5830*	5830*	5040	3650			3500*	3270	6356
4.5m	8490*	8490*	7160*	5610	4970	3580			3250*	2670	7145
3.0m			7490	5200	4800	3430	3400	2430	3190*	2400	7557
1.5m			7100	4860	4630	3270	3350	2380	3250	2310	7654
0m			6920	4700	4520	3170			3360	2380	7449
- 1.5m	7580*	7580*	6770*	4700	4510	3160			3560*	2660	6914

**LIFT CAPACITIES – DIPPER LENGTH: 2.70M, 5.35M T.A.B., TRACKSHOES: 700MM, NO BUCKET. JS160 LC T.A.B.**







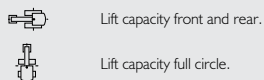



Reach	3m		4.5m		6m		7.5m		Capacity at Max Reach		mm
											
Load Point Ht.	kg	kg	kg	kg	kg	kg	kg	kg	kg	kg	mm
9.0m	5360*	5360*							4260*	4260*	3449
7.5m			4780*	4780*					2990*	2990*	5649
6.0m			4650*	4650*	4580*	3720			2590*	2590*	6869
4.5m	5140*	5140*	5500*	5500*	5020	3630	3130*	2490	2440*	2420	7604
3.0m			7590	5300	4830	3450	3420	2450	2410*	2200	7992
1.5m			7150	4900	4640	3270	3340	2370	2480	2120	8084
0m			6910	4690	4500	3150	3280	2320	2670*	2170	7890
- 1.5m	7430*	7430*	6850	4640	4460	3110			3030*	2390	7388
- 3.0m			5210*	4720	3590*	3180			3160*	3020	6264











**LIFT CAPACITIES – DIPPER LENGTH: 3.05M, 5.35M T.A.B., TRACKSHOES: 700MM, NO BUCKET. JS160 LC T.A.B.**











Reach	3m		4.5m		6m		7.5m		Capacity at Max Reach		mm
											
Load Point Ht.	kg	kg	kg	kg	kg	kg	kg	kg	kg	kg	mm
9.0m	5100*	5100*							3550*	3550*	4269
7.5m			4190*	4190*	3370*	3370*			2610*	2610*	6178
6.0m			3830*	3830*	4120*	3730			2260*	2260*	7309
4.5m	3140*	3140*	4240*	4240*	4500*	3620	3460	2480	2120*	2120*	8003
3.0m			7620	5310	4810	3430	3380	2410	2080*	1980	8372
1.5m			7120	4870	4590	3220	3280	2320	2110*	1920	8460
0m			6820	4590	4430	3070	3210	2250	2230*	1960	8275
- 1.5m	6500*	6500*	6720	4510	4360	3010	3200	2240	2480*	2140	7798
- 3.0m	7060*	7060*	5660*	4560	4070*	3050			2760*	2590	6857



- Notes:
1. The above loads are in compliance with SAE and ISO Hydraulic Excavator Lift Capacity Standards.
  2. They do not exceed 87% of hydraulic lifting capacity or 75% of tipping load.
  3. Rated loads marked with an asterisk(\*) are limited by hydraulic capacity rather than tipping load.
  4. Lift capacities above are calculated with articulated boom at full reach.

LIFT CAPACITIES – DIPPER LENGTH: 2.25M, 5.35M T.A.B., TRACKSHOES: 500MM, NO BUCKET.											JSI60 NLC T.A.B.
Reach	3m		4.5m		6m		7.5m		Capacity at Max Reach		
											
Load Point Ht.	kg	kg	kg	kg	kg	kg	kg	kg	kg	kg	mm
9.0m									7240*	7240*	2218
7.5m	5930*	5930*	5780*	5150					4160*	4160*	5009
6.0m	5030*	5030*	5830*	5160	4890	3200			3500*	2860	6356
4.5m	8490*	8490*	7160*	4900	4820	3130			3250*	2320	7145
3.0m			7270	4510	4650	2980	3290	2110	3190*	2080	7557
1.5m			6880	4170	4880	2830	3240	2060	3140	2000	7654
0m			6700	4020	4380	2730			3250	2060	7449
- 1.5m	7580*	7500*	6700	4010	4370	2720			3560*	2290	6914

LIFT CAPACITIES – DIPPER LENGTH: 2.70M, 5.35M T.A.B., TRACKSHOES: 500MM, NO BUCKET.											JSI60 NLC T.A.B.
Reach	3m		4.5m		6m		7.5m		Capacity at Max Reach		
											
Load Point Ht.	kg	kg	kg	kg	kg	kg	kg	kg	kg	kg	mm
9.0m	5360*	5360*							4260*	4260*	3449
7.5m			4780*	4780*					2990*	2990*	5649
6.0m			4650*	4650*	4580*	3270			2590*	2540	6869
4.5m	5140*	5140*	5500*	5000	4870	3180	3130*	2170	2440*	2100	7604
3.0m			7380	4590	4690	3010	3310	2120	2410*	1900	7992
1.5m			6930	4210	4490	2830	3230	2050	2480*	1820	8084
0m			6690	4000	4360	2710	3180	2000	2670*	1870	7890
- 1.5m	7430*	7350	6640	3960	4320	2670			3030*	2060	7388
- 3.0m			5210*	4030	3590*	2740			3160*	2600	6264

LIFT CAPACITIES – DIPPER LENGTH: 3.05M, 5.35M T.A.B., TRACKSHOES: 500MM, NO BUCKET.											JSI60 NLC T.A.B.
Reach	3m		4.5m		6m		7.5m		Capacity at Max Reach		
											
Load Point Ht.	kg	kg	kg	kg	kg	kg	kg	kg	kg	kg	mm
9.0m	5100*	5100*							3550*	3550*	4269
7.5m			4190*	4190*	3370*	3210			2610*	2610*	6178
6.0m			3830*	3830*	4120*	3280			2260*	2240	7309
4.5m	3410*	3410*	4240*	4240*	4500*	3170	3350	2150	2120*	1880	8003
3.0m			7400	4600	4670	2980	3270	2080	2080*	1700	8372
1.5m			6910	4180	4450	2780	3180	1990	2110*	1640	8460
0m			6600	3910	4280	2630	3100	1920	2230*	1680	8275
- 1.5m	6500*	6500*	6510	3830	4210	2570	3090	1910	2480*	1830	7798
- 3.0m	7060*	7060*	5660*	3880	4070*	2610			2760*	2230	6857

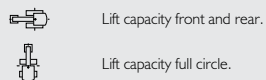

Notes:

1. The above loads are in compliance with SAE and ISO Hydraulic Excavator Lift Capacity Standards.
2. They do not exceed 87% of hydraulic lifting capacity or 75% of tipping load.
3. Rated loads marked with an asterisk(\*) are limited by hydraulic capacity rather than tipping load.
4. Lift capacities above are calculated with articulated boom at full reach.

**LIFT CAPACITIES – DIPPER LENGTH: 2.25M, 5.15M MONOBOOM, TRACKSHOES: 700MM, NO BUCKET. JS180 LC MONO**

Reach	1.5m		3m		4.5m		6m		7.5m		Capacity at Max Reach		
													
Load Point Ht.	kg	kg	kg	kg	kg	kg	kg	kg	kg	kg	kg	kg	mm
7.5m					4040*	4040*					3860*	3860*	4537
6.0m											3330*	3330*	5985
4.5m					5560*	5560*	5010*	4050			3190*	3190*	6811
3.0m					6930*	5920	5550*	3920			3230*	2970	7235
1.5m					8220*	5610	5900	3780			3440*	2860	7330
0m			5370*	5370*	8840*	5450	5800	3690			3870*	2950	7108
- 1.5m	6090*	6090*	10850*	10150	8690*	5420	5780	3670			4740*	3290	6537
- 3.0m			10740*	10320	7590*	5500					5830*	4200	5507

**LIFT CAPACITIES – DIPPER LENGTH: 2.70M, 5.15M MONOBOOM, TRACKSHOES: 700MM, NO BUCKET. JS180 LC MONO**

Reach	1.5m		3m		4.5m		6m		7.5m		Capacity at Max Reach		
													
Load Point Ht.	kg	kg	kg	kg	kg	kg	kg	kg	kg	kg	kg	kg	mm
7.5m											2800*	2800*	5165
6.0m							3880*	3880*			2490*	2490*	6471
4.5m					5000*	5000*	4620*	4080			2400*	2400*	7241
3.0m			9720*	9720*	6400*	5990	5220*	3940	3220*	2820	2450*	2450*	7641
1.5m			5040*	5040*	7830*	5650	5900*	3790	4000*	2760	2600*	2600*	7731
0m			6450*	6450*	8670*	5440	5780	3670	3100*	2720	2920*	2710	7521
- 1.5m	5830*	5830*	10170*	10040	8770*	5370	5730	3630			3520*	2980	6985
- 3.0m	9880*	9880*	11560*	10180	8020*	5420	5360*	3680			4880*	3660	6033
- 4.5m			8370*	8370*							5580*	5580*	4396

**LIFT CAPACITIES – DIPPER LENGTH: 3.05M, 5.15M MONOBOOM, TRACKSHOES: 700MM, NO BUCKET. JS180 LC MONO**

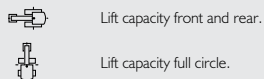

Reach	1.5m		3m		4.5m		6m		7.5m		Capacity at Max Reach		
													
Load Point Ht.	kg	kg	kg	kg	kg	kg	kg	kg	kg	kg	kg	kg	mm
7.5m											2430*	2430*	5738
6.0m							3890*	3890*			2160*	2160*	6935
4.5m							4270*	4060	2730*	2730*	2070*	2070*	7657
3.0m			8600*	8600*	5910*	5910*	4900*	3910	3940*	2780	2080*	2080*	8037
1.5m			6010*	6010*	7410*	5600	5620*	3730	4200	2710	2180*	2180*	8122
0m			6180*	6180*	8410*	5360	5710	3600	4130	2640	2390*	2390*	7923
- 1.5m	4960*	4960*	9110*	9110*	8680*	5260	5640	3530			2800*	2670	7416
- 3.0m	8470*	8470*	11930*	9950	8160*	5280	5670	3560			3630*	3200	6528
- 4.5m			9250*	9250*	6250*	5460					5160*	4660	5059













**Notes:**

1. The above loads are in compliance with SAE and ISO Hydraulic Excavator Lift Capacity Standards.
2. They do not exceed 87% of hydraulic lifting capacity or 75% of tipping load.
3. Rated loads marked with an asterisk(\*) are limited by hydraulic capacity rather than tipping load.



LIFT CAPACITIES – DIPPER LENGTH: 2.25M, 5.15M MONOBOOM, TRACKSHOES: 500MM, NO BUCKET.													JSI80 NLC MONO
Reach	1.5m		3m		4.5m		6m		7.5m		Capacity at Max Reach		
													
Load Point Ht.	kg	kg	kg	kg	kg	kg	kg	kg	kg	kg	kg	kg	mm
7.5m					4040*	4040*					3860*	3860*	4537
6.0m											3330*	3330*	5985
4.5m					5560*	5520	5010*	3580			3190*	2930	6811
3.0m					6930*	5200	5550*	3460			3230*	2620	7235
1.5m					8220*	4910	5660	3330			3440*	2520	7330
0m			5370*	5370*	8630	4750	5560	3240			3870*	2590	7108
- 1.5m	6090*	6090*	10850*	8680	8590	4720	5530	3220			4740*	2890	6537
- 3.0m			10740*	8840	7590*	4800					5830*	3690	5507





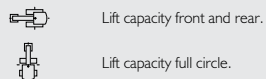

LIFT CAPACITIES – DIPPER LENGTH: 2.70M, 5.15M MONOBOOM, TRACKSHOES: 500MM, NO BUCKET.													JSI80 NLC MONO
Reach	1.5m		3m		4.5m		6m		7.5m		Capacity at Max Reach		
													
Load Point Ht.	kg	kg	kg	kg	kg	kg	kg	kg	kg	kg	kg	kg	mm
7.5m											2800*	2800*	5165
6.0m							3880*	3680			2490*	2490*	6471
4.5m					5000*	5000*	4620*	3620			2400*	2400*	7241
3.0m			9720*	9640*	6400*	5270	5220*	3480	3220*	2490	2450*	2410	7641
1.5m			5040*	5040*	7830*	4940	5670	3330	4000*	2430	2600*	2320	7731
0m			6450*	6450*	8630	4740	5540	3220	3100*	2380	2920*	2370	7521
- 1.5m	5830*	5830*	10170*	8580	8540	4670	5490	3170			3520*	2610	6985
- 3.0m	9880*	9880*	11560*	8700	8020*	4720	5360*	3230			4880*	3200	6033
- 4.5m			8370*	8370*							5580*	5100	4396

LIFT CAPACITIES – DIPPER LENGTH: 3.05M, 5.15M MONOBOOM, TRACKSHOES: 500MM, NO BUCKET.													JSI80 NLC MONO
Reach	1.5m		3m		4.5m		6m		7.5m		Capacity at Max Reach		
													
Load Point Ht.	kg	kg	kg	kg	kg	kg	kg	kg	kg	kg	kg	kg	mm
7.5m											2430*	2430*	5738
6.0m							3890*	3680			2160*	2160*	6935
4.5m							4270*	3600	2730*	2500	2070*	2070*	7657
3.0m			8600*	8600*	5910*	5270	4900*	3450	3940*	2450	2080*	2080*	8037
1.5m			6010*	6010*	7410*	4900	5620*	3270	4020	2370	2180*	2100	8122
0m			6180*	6180*	8410*	4660	5470	3140	3950	2310	2390*	2140	7923
- 1.5m	4960*	4960*	9110*	8370	8420	4560	5390	3080			2800*	2330	7416
- 3.0m	8470*	8470*	11930*	8480	8160*	4580	5420	3100			3630*	2800	6528
- 4.5m			9250*	8760	6250*	4750					5160*	4080	5059













Notes: 1. The above loads are in compliance with SAE and ISO Hydraulic Excavator Lift Capacity Standards.  
 2. They do not exceed 87% of hydraulic lifting capacity or 75% of tipping load.  
 3. Rated loads marked with an asterisk(\*) are limited by hydraulic capacity rather than tipping load.











**LIFT CAPACITIES – DIPPER LENGTH: 2.25M, 5.35M T.A.B., TRACKSHOES: 700MM, NO BUCKET. JS180 LC T.A.B.**

Reach	3m		4.5m		6m		7.5m		Capacity at Max Reach		
											mm
Load Point Ht.	kg	kg	kg	kg	kg	kg	kg	kg	kg	kg	mm
9.0m									7030*	7030*	2326
7.5m	5900*	5900*	5800*	5800*					4130*	4130*	5047
6.0m	5030*	5030*	5830*	5830*	5250*	4030			3490*	3490*	6377
4.5m	8900*	8900*	7240*	6160	6040*	3970			3250*	2980	7157
3.0m			8340*	5750	6000	3810	3920*	2730	3200*	2690	7562
1.5m			8680	5410	5830	3650	5210	2680	3280*	2600	7653
0m			8130*	5260	5720	3560			3540*	2690	7441
- 1.5m	7710*	7710*	6730*	5250	5010*	3550			3550*	3000	6898

**LIFT CAPACITIES – DIPPER LENGTH: 2.70M, 5.35M T.A.B., TRACKSHOES: 700MM, NO BUCKET. JS180 LC T.A.B.**







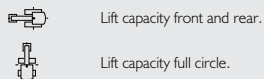



Reach	3m		4.5m		6m		7.5m		Capacity at Max Reach		
											mm
Load Point Ht.	kg	kg	kg	kg	kg	kg	kg	kg	kg	kg	mm
9.0m	5400*	5400*							4200*	4220*	3157
7.5m			4780*	4780*					2980*	2980*	5682
6.0m			4660*	4660*	4600*	4110			2590*	2590*	6889
4.5m	5420*	5240*	5540*	5540*	5340*	4010	3190*	2790	2440*	2440*	7616
3.0m			8040*	5840	6040	3840	2480	2740	2410*	2410*	7997
1.5m			8620*	5450	5840	3660	4200	2670	2480*	2390	8083
0m			8360*	5240	5700	3540	4140	2620	2670*	2460	7883
- 1.5m	7520*	7520*	7230*	5190	5390*	3500			3050*	2700	7373
- 3.0m			5150*	5150*	3530*	3530*			3190*	3190*	6210



**LIFT CAPACITIES – DIPPER LENGTH: 3.05M, 5.35M T.A.B., TRACKSHOES: 700MM, NO BUCKET. JS180 LC T.A.B.**







Reach	3m		4.5m		6m		7.5m		Capacity at Max Reach		
											mm
Load Point Ht.	kg	kg	kg	kg	kg	kg	kg	kg	kg	kg	mm
9.0m	5080*	5080*							3510*	3510*	4324
7.5m			4180*	4180*	3440*	3440*			2600*	2600*	6208
6.0m			3830*	3830*	4120*	4120			2260*	2260*	7327
4.5m	3440*	3440*	4260*	4260*	4520*	4000	3820*	2780	2110*	2110*	8014
3.0m			7710*	5850	5900*	3810	4240	2700	2070*	2070*	8377
1.5m			8430*	5410	5790	3610	4150	2610	2110*	2110*	8459
0m			8370*	5150	5620	3460	4070	2540	2240*	2230	8268
- 1.5m	6580*	6580*	7440*	5070	5530*	3400	3810*	2510	2490*	2440	7784
- 3.0m	6990*	6990*	5610*	5130	4030*	3440			2780*	2780*	6815



- Notes:
1. The above loads are in compliance with SAE and ISO Hydraulic Excavator Lift Capacity Standards.
  2. They do not exceed 87% of hydraulic lifting capacity or 75% of tipping load.
  3. Rated loads marked with an asterisk(\*) are limited by hydraulic capacity rather than tipping load.
  4. Lift capacities above are calculated with articulated boom at full reach.



LIFT CAPACITIES – DIPPER LENGTH: 2.25M, 5.35M T.A.B., TRACKSHOES: 500MM, NO BUCKET.											JSI80 NLC T.A.B.
Reach	3m		4.5m		6m		7.5m		Capacity at Max Reach		
											
Load Point Ht.	kg	kg	kg	kg	kg	kg	kg	kg	kg	kg	mm
9.0m									7030*	7030*	2326
7.5m	5900*	5900*	5800*	5680					4130*	4130*	5047
6.0m	5030*	5030*	5830*	5680	5250*	3560			3490*	3180	6377
4.5m	8900*	8900*	7240*	5420	5930	3500			3250*	2610	7157
3.0m			8340*	5030	5760	3340	3920*	2390	3200*	2350	7562
1.5m			8680	4700	5580	3190	4030	2340	3280*	2270	7653
0m			8130*	4550	5470	3100			3540*	2340	7441
- 1.5m	7710*	7710*	6730*	4540	5010*	3090			3550*	2610	6898



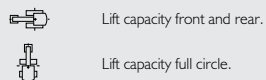







LIFT CAPACITIES – DIPPER LENGTH: 2.70M, 5.35M T.A.B., TRACKSHOES: 500MM, NO BUCKET.											JSI80 NLC T.A.B.
Reach	3m		4.5m		6m		7.5m		Capacity at Max Reach		
											
Load Point Ht.	kg	kg	kg	kg	kg	kg	kg	kg	kg	kg	mm
9.0m	5400*	5400*							4220*	4220*	3157
7.5m			4780*	4780*					2980*	2980*	5682
6.0m			4660*	4660*	4600*	3630			2590*	2590*	6889
4.5m	5420*	5240*	5540*	5520	5340*	3540	3190*	2450	2440*	2370	7616
3.0m			8040*	5110	5790	3370	4100	2400	2410*	2160	7997
1.5m			8620*	4740	5590	3200	4020	2330	2480*	2080	8083
0m			8630*	4530	5460	3080	3960	2280	2670*	2140	7883
- 1.5m	7520*	7520*	7230*	4490	5390*	3040			3050*	5350	7373
- 3.0m			5150*	4570	3530*	3110			3190*	2980	6210







LIFT CAPACITIES – DIPPER LENGTH: 3.05M, 5.35M T.A.B., TRACKSHOES: 500MM, NO BUCKET.											JSI80 NLC T.A.B.
Reach	3m		4.5m		6m		7.5m		Capacity at Max Reach		
											
Load Point Ht.	kg	kg	kg	kg	kg	kg	kg	kg	kg	kg	mm
9.0m	5080*	5080*							3510*	3510*	4324
7.5m			4180*	4180*	3440*	3440*			2600*	2600*	6208
6.0m			3830*	3830*	4120*	3640			2260*	2260*	7327
4.5m	3440*	3440*	4260*	4260*	4520*	3530	3820*	2430	2110*	2110*	8014
3.0m			7710*	5120	5770	3340	4060	2360	2070*	1950	8377
1.5m			8430*	4700	5550	3140	3960	2270	2110*	1880	8459
0m			8370*	4440	5380	3000	3890	2220	2240*	1930	8268
- 1.5m	6580*	6580*	7440*	4360	5310	2940	3810*	2190	2490*	2110	7784
- 3.0m	6990*	6990*	5610*	4420	4030*	2980			2780*	2560	6815



- Notes:
1. The above loads are in compliance with SAE and ISO Hydraulic Excavator Lift Capacity Standards.
  2. They do not exceed 87% of hydraulic lifting capacity or 75% of tipping load.
  3. Rated loads marked with an asterisk(\*) are limited by hydraulic capacity rather than tipping load.
  4. Lift capacities above are calculated with articulated boom at full reach.

LIFT CAPACITIES – DIPPER LENGTH: 2.25M, 5.15M MONOBOOM, TRACKSHOES: 700MM, NO BUCKET.													JS190 LC MONO	
Reach	1.5m		3m		4.5m		6m		7.5m		Capacity at Max Reach			
														
Load Point Ht.	kg	kg	kg	kg	kg	kg	kg	kg	kg	kg	kg	kg	kg	mm
7.5m												3900*	3900*	4484
6.0m												3350*	3350*	5956
4.5m					5520*	5520*	5000*	4230				3200*	3200*	6795
3.0m					6880*	6170	5530*	4100				3230*	3130	7230
1.5m					8190*	5870	6130	3970				3420*	3010	7334
0m			5250*	5250*	8830*	5710	6020	3870				3830*	3100	7122
- 1.5m	5940*	5940*	10670*	10600	8710*	5680	6000	3850				4660*	3450	6562
- 3.0m			10810*	10770	7650*	5760						5830*	4360	5548
- 4.5m														



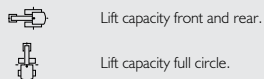

LIFT CAPACITIES – DIPPER LENGTH: 2.70M, 5.15M MONOBOOM, TRACKSHOES: 700MM, NO BUCKET.													JS190 LC MONO	
Reach	1.5m		3m		4.5m		6m		7.5m		Capacity at Max Reach			
														
Load Point Ht.	kg	kg	kg	kg	kg	kg	kg	kg	kg	kg	kg	kg	kg	mm
7.5m												2910*	2910*	5120
6.0m							3910*	3910*				2590*	2590*	6445
4.5m					4990*	4990*	4630*	4290				2490*	2490*	7227
3.0m			9550*	9550*	6360*	6250	5220*	4140	3280*	2990		2530*	2530*	7637
1.5m			5180*	5180*	7780*	5900	5890*	3980	4080*	2930		2680*	2680*	7735
0m			6460*	6460*	8640*	5680	6010	3860	3270*	2880		2980*	2860	7534
- 1.5m	5810*	5810*	10130*	10130*	8760*	5610	5960	3810				3570*	3140	7008
- 3.0m	9840*	9840*	11570*	10570	8050*	5660	5720*	3870				4890*	3820	6070
- 4.5m			8490*	8490*								5610*	5610*	4463

LIFT CAPACITIES – DIPPER LENGTH: 3.00M, 5.15M MONOBOOM, TRACKSHOES: 700MM, NO BUCKET.													JS190 LC MONO	
Reach	1.5m		3m		4.5m		6m		7.5m		Capacity at Max Reach			
														
Load Point Ht.	kg	kg	kg	kg	kg	kg	kg	kg	kg	kg	kg	kg	kg	mm
7.5m												2430*	2430*	5581
6.0m							3770*	3770*				2180*	2180*	6816
4.5m							4310*	4290	2360*	2360*		2110*	2110*	7559
3.0m			8530*	8530*	5920*	5920*	4930*	4130	3720*	2970		2140*	2140*	7951
1.5m			7030*	7030*	7440*	5930	5670*	3960	4410	2890		2270*	2270*	8045
0m			6820*	6820*	8460*	5680	5990	3830	4350	2830		2520*	2520*	7853
- 1.5m	5390*	5390*	9600*	9600*	8750*	5580	5910	3770				2990*	2890	7350
- 3.0m	8770*	8770*	12070*	10500	8260*	5600	5940	3790				3980*	3460	6463
- 4.5m			9460*	9460	6420*	5770						5510*	5030	4987



Notes: 1. The above loads are in compliance with SAE and ISO Hydraulic Excavator Lift Capacity Standards.  
 2. They do not exceed 87% of hydraulic lifting capacity or 75% of tipping load.  
 3. Rated loads marked with an asterisk(\*) are limited by hydraulic capacity rather than tipping load.

LIFT CAPACITIES – DIPPER LENGTH: 2.25M, 5.15M MONOBOOM, TRACKSHOES: 500MM, NO BUCKET.													JSI90 NLC MONO	
Reach	1.5m		3m		4.5m		6m		7.5m		Capacity at Max Reach			
														
Load Point Ht.	kg	kg	kg	kg	kg	kg	kg	kg	kg	kg	kg	kg	mm	
7.5m												3900*	3900*	4484
6.0m												3350*	3350*	5956
4.5m					5520*	5520*	5000*	3790				3200*	3130	6795
3.0m					6880*	5500	5530*	3670				3230*	2800	7230
1.5m					8190*	5200	5950	3540				3420*	2690	7334
0m			2250*	5250*	8830*	5040	5840	3450				3830*	2760	7122
- 1.5m	5940*	5940*	10670*	9190	8710*	5010	5820	3430				4660*	3070	6562
- 3.0m			10810*	9340	7650*	5100						5830*	3880	5548
- 4.5m														





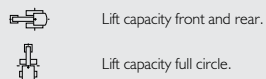





LIFT CAPACITIES – DIPPER LENGTH: 2.70M, 5.15M MONOBOOM, TRACKSHOES: 500MM, NO BUCKET.													JSI90 NLC MONO	
Reach	1.5m		3m		4.5m		6m		7.5m		Capacity at Max Reach			
														
Load Point Ht.	kg	kg	kg	kg	kg	kg	kg	kg	kg	kg	kg	kg	mm	
7.5m												2910*	2910*	5120
6.0m							3910*	3910*				2590*	2590*	6445
4.5m					4990*	4990*	4630*	3850				2490*	2490*	7227
3.0m			9550*	9550*	6360*	5770	5220*	3710	3280*	2670		2530*	2530*	7637
1.5m			5180*	5180*	7780*	5220	5890*	3550	4080*	2610		2680*	2500	7735
0m			6460*	6460*	8640*	5010	5830	3430	3270*	2560		2980*	2550	7534
- 1.5m	5810*	5810*	10130*	9010	8760*	4950	5780	3880				3570*	2790	7008
- 3.0m	9840*	9840*	11570*	19150	8050*	5000	5720*	3440				4890*	3400	6070
- 4.5m			8490*	8490*								5610*	5300	4463

LIFT CAPACITIES – DIPPER LENGTH: 3.00M, 5.15M MONOBOOM, TRACKSHOES: 700MM, NO BUCKET.													JSI90 NLC MONO	
Reach	1.5m		3m		4.5m		6m		7.5m		Capacity at Max Reach			
														
Load Point Ht.	kg	kg	kg	kg	kg	kg	kg	kg	kg	kg	kg	kg	mm	
7.5m												2430*	2430*	5581
6.0m							3770*	3770*				2180*	2180*	6816
4.5m							4310*	3850	2360*	2360*		2110*	2110*	7559
3.0m			8530*	8530*	5920*	5610	4930*	3700	3720*	2650		2140*	2140*	7951
1.5m			7030*	7030*	7440*	5250	5670*	3530	4280	2580		2270*	2270*	8045
0m			6820*	6820*	8460*	5010	5810	3400	4210	2520		2520*	2370*	7853
- 1.5m	5390*	5390*	9600*	8970*	8750*	4920	5740	3340				2990*	2570	7350
- 3.0m	8770*	8770*	12070*	9080	8260*	4940	5760	3360				3980*	3070	6463
- 4.5m			9460*	9350	6420*	5110						5510*	4460	4987













Notes: 1. The above loads are in compliance with SAE and ISO Hydraulic Excavator Lift Capacity Standards.  
 2. They do not exceed 87% of hydraulic lifting capacity or 75% of tipping load.  
 3. Rated loads marked with an asterisk(\*) are limited by hydraulic capacity rather than tipping load.











**LIFT CAPACITIES – DIPPER LENGTH: 2.25M, 5.35M T.A.B., TRACKSHOES: 700MM, NO BUCKET. JSI90 LC T.A.B.**

Reach	3m		4.5m		6m		7.5m		Capacity at Max Reach		
											
Load Point Ht.	kg	kg	kg	kg	kg	kg	kg	kg	kg	kg	mm
9.0m									7350*	7350*	2181
7.5m	5950*	5950*	5790*	5790*					4190*	4190*	4997
6.0m	5040*	5040*	5840*	5840*	5210*	4210			3520*	3520*	6349
4.5m	8330*	8330*	7140*	6400	6060*	4140			3270*	3140	7141
3.0m			8350*	6000	6200	3990	3870*	2870	3200*	2840	7556
1.5m			8730*	5660	6020	3830	4360	2820	3290*	2750	7655
0m			8200*	5510	5920	3740			3530*	2830	7452
- 1.5m	7550*	7550*	6820*	5500	5090*	3730			3600*	3140	6920

**LIFT CAPACITIES – DIPPER LENGTH: 2.70M, 5.35M T.A.B., TRACKSHOES: 700MM, NO BUCKET. JSI90 LC T.A.B.**

Reach	3m		4.5m		6m		7.5m		Capacity at Max Reach		
											
Load Point Ht.	kg	kg	kg	kg	kg	kg	kg	kg	kg	kg	mm
9.0m	5450*	5450*							4390*	4390*	3428
7.5m			4870*	4870*					3100*	3100*	5640
6.0m			4730*	4730*	4660*	4310			2700*	2700*	6864
4.5m	5160*	5160*	5540*	5540*	5380*	4210	3210*	2950	2540*	2540*	7602
3.0m			8050*	6090	6180*	4030	4460	2900	2510*	2510*	7992
1.5m			8640*	5690	6040	3850	4370	2830	2580*	2540	8086
0m			8400*	5470	5900	3720	4320	2780	2760*	2600	7894
- 1.5m	7490*	7490*	7300*	5420	5470*	3680			3130*	2850	7394
- 3.0m			5260*	5260*	3660*	3660*			3190*	3190*	6289





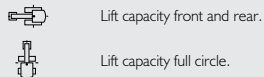





**LIFT CAPACITIES – DIPPER LENGTH: 3.00M, 5.35M T.A.B., TRACKSHOES: 700MM, NO BUCKET. JSI90 LC T.A.B.**











Reach	3m		4.5m		6m		7.5m		Capacity at Max Reach		
											
Load Point Ht.	kg	kg	kg	kg	kg	kg	kg	kg	kg	kg	mm
9.0m	4950*	4950*							3420*	3420*	4152
7.5m			4230*	4230*	3000*	3000*			2570*	2570*	6102
6.0m			4010*	4010*	4150*	4150*			2270*	2270*	7247
4.5m	3880*	3880*	4560*	4560*	4660*	4210	3660*	2950	2140*	2140*	7949
3.0m			7770*	6150	6010*	4030	4440	2890	2120*	2120*	8322
1.5m			8520*	5730	6040	3840	4340	2800	2180*	2180*	8413
0m	4230*	4230*	8500	5470	5880	3690	4270	2730	2330*	2330*	8229
- 1.5m	7140*	7140*	7600*	5380	5660*	3630	3940*	2720	2640*	2620	7750
- 3.0m	7240*	7240*	5800*	5440	4190*	3670			2850*	2850*	6867













**Notes:**

1. The above loads are in compliance with SAE and ISO Hydraulic Excavator Lift Capacity Standards.
2. They do not exceed 87% of hydraulic lifting capacity or 75% of tipping load.
3. Rated loads marked with an asterisk(\*) are limited by hydraulic capacity rather than tipping load.

LIFT CAPACITIES – DIPPER LENGTH: 2.25M, 5.35M T.A.B., TRACKSHOES: 500MM, NO BUCKET.											JSI90 NLC T.A.B.
Reach	3m		4.5m		6m		7.5m		Capacity at Max Reach		mm
											
Load Point Ht.	kg	kg	kg	kg	kg	kg	kg	kg	kg	kg	mm
9.0m									7350*	7350*	2181
7.5m	5950*	5950*	5790*	5790*					4190*	4190*	4997
6.0m	5040*	5040*	5840*	5840*	5210*	3770			3520*	3400	6349
4.5m	8330*	8330*	7140*	5700	6060*	3700			3270*	2800	7141
3.0m			8350*	5320	6020	3550	3870*	2550	3200*	2520	7556
1.5m			8730*	4990	5840	3400	4230	2510	3290*	2430	7655
0m			8200*	4840	5740	3300			3530*	2510	7452
- 1.5m	7550*	7550*	6820*	4830	5090*	3290			3600*	2780	6920

LIFT CAPACITIES – DIPPER LENGTH: 2.70M, 5.35M T.A.B., TRACKSHOES: 500MM, NO BUCKET.											JSI90 NLC T.A.B.
Reach	3m		4.5m		6m		7.5m		Capacity at Max Reach		mm
											
Load Point Ht.	kg	kg	kg	kg	kg	kg	kg	kg	kg	kg	mm
9.0m	5450*	5450*							4390*	4390*	3428
7.5m			4870*	4870*					3100*	3100*	5640
6.0m			4730*	4730*	4660*	3860			2700*	2700*	6864
4.5m	5160*	5160*	5540*	5540*	5380*	3770	3210*	2630	2540*	2540*	7602
3.0m			8050*	5410	6070	3590	4320	2580	2510*	2330	7992
1.5m			8640*	5010	5860	3410	4240	2510	2580*	2250	8086
0m			8400*	4800	5720	3280	4180	2460	2760*	2310	7894
- 1.5m	7490*	7490*	7300*	4750	5470*	3250			3130*	2520	7394
- 3.0m			5260*	4830	3660*	3320			3190*	3140	6289

LIFT CAPACITIES – DIPPER LENGTH: 3.00M, 5.35M T.A.B., TRACKSHOES: 500MM, NO BUCKET.											JSI90 NLC T.A.B.
Reach	3m		4.5m		6m		7.5m		Capacity at Max Reach		mm
											
Load Point Ht.	kg	kg	kg	kg	kg	kg	kg	kg	kg	kg	mm
9.0m	4950*	4950*							3420*	3420*	4152
7.5m			4230*	4230*	3000*	3000*			2570*	2570*	6102
6.0m			4010*	4010*	4150*	3870			2270*	2270*	7247
4.5m	3880*	3880*	4560*	4560*	4660*	3770	3660*	2630	2140*	2140*	7949
3.0m			7770*	5460	6010*	3590	4300	2560	2120*	2120*	8322
1.5m			8520*	5050	5860	3400	4210	2480	2180*	2090	8413
0m	4230*	4230*	8500*	4800	5700	3260	4140	2410	2330*	2130	8229
- 1.5m	7140*	7140*	7600*	4710	5630	3200	3940*	2400	2640*	2320	7750
- 3.0m	7240*	7240*	5800*	4770	4190*	3240			2850*	2760	6867

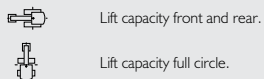

Notes: 1. The above loads are in compliance with SAE and ISO Hydraulic Excavator Lift Capacity Standards.  
 2. They do not exceed 87% of hydraulic lifting capacity or 75% of tipping load.  
 3. Rated loads marked with an asterisk(\*) are limited by hydraulic capacity rather than tipping load.



**ONE COMPANY, OVER 300 MACHINES.**

Your nearest JCB dealer

**Hydraulic Excavator JS160/180/190 NLC/LC**

Engine power: 93kW (125hp) Bucket capacity: 0.46 – 0.85m<sup>3</sup>

Operating weight: 17,235 – 21,225kg

JCB Sales Limited, Rokeceter, Staffordshire, United Kingdom ST14 5JP.

Tel: +44 (0)1889 590312 Email: [salesinfo@jcb.com](mailto:salesinfo@jcb.com)

Download the very latest information on this product range at: [www.jcb.com](http://www.jcb.com)

©2009 JCB Sales. All rights reserved. No part of this publication may be reproduced, stored in a retrieval system, or transmitted in any form or by any other means, electronic, mechanical, photocopying or otherwise, without prior permission from JCB Sales. All references in this publication to operating weights, sizes, capacities and other performance measurements are provided for guidance only and may vary dependant upon the exact specification of machine. They should not therefore be relied upon in relation to suitability for a particular application. Guidance and advice should always be sought from your JCB Dealer. JCB reserves the right to change specifications without notice. Illustrations and specifications shown may include optional equipment and accessories. The JCB logo is a registered trademark of J C Bamford Excavators Ltd.

